

X-Cite® 120Q User Guide

Applies to 120 Q Series Models:

- XE120-Q, XE120-QX
- XI120-Q, XI120-QX

X-Cite® 120Q User Guide

035-00327R Rev. 4

Made in Canada

Excelitas Canada Inc. 2018

All rights reserved

No part of this publication may be reproduced, transmitted, transcribed, stored in a retrieval system or translated into any language in any form by any means without the prior written consent of Excelitas Canada Inc. Every effort has been made to insure information in this manual is accurate, however, information in this manual is subject to change without notice and does not represent a commitment on the part of the authors.



Excelitas Canada Inc.
2260 Argentia Road
Mississauga ON L5N 6H7 CANADA

Trademarks

X-Cite® and Intelli-Lamp® are registered trademarks of Excelitas Canada Inc..
All other product names are trademarks of their respective owners.







Table of Contents

1	X-Cite® 120Q Message Reference	1
2	Introduction	2
3	Getting Started	3
3.1	Box Contents	3
3.2	Front Panel	4
3.3	Rear Panel	4
4	Safety Information	5
4.1	Glossary of Symbols	5
4.2	Safety Precautions	5
5	Installing the Lamp Module	9
6	Inserting and Removing the Light Guide	14
7	Installing the Collimating Adapter	16
8	Powering Up and Powering Down	18
9	Viewing the Accumulated Lamp Hours	19
10	Adjusting the Illumination (Optional)	20
11	Troubleshooting	21
11.1	General	21
11.2	Liquid Light Guides	23
11.3	Lamps	26
11.4	Air Vents & Filters	27
12	Routine Care and Maintenance	29
12.1	General tips to help maximize lamp lifetime	30
13	Technical Specifications	31
13.1	Lamp module	31
13.2	Light guide	32
13.3	Power Input	33
13.4	Lamp power (electrical)	33
13.5	Environmental Specifications:	34
13.6	Regulatory Compliance	35
13.7	China RoHS	36
14	Warranty	37
15	Contact Information	38
15.1	Web Page	38
15.2	Service Centers	38
15.3	Replacement Parts	38

Figures

Figure 1 Front Panel View	4
Figure 2 Rear Panel View.....	4
Figure 3 Side Panel-Lamp Access Panel	9
Figure 4 Lamp Housing	10
Figure 5 Lamp Orientation.....	10
Figure 6 Intelli-Lamp Connection.....	11
Figure 7 Lamp Power Connection	12
Figure 8 Lamp Wire Orientation	12
Figure 9 Light Guide Insertion	14
Figure 10 Collimating Adaptor	17
Figure 11 Iris Adjustment Wheel.....	20
Figure 12 Iris Adjustment Settings.....	20

1 X-Cite® 120Q Message Reference

Symbol	Message	Description
XXXX H	Lamp Hours	Displays the accumulated hours the lamp has been on
	Constant bulb	The lamp is on and ready for use
	Flashing bulb	Lamp is striking or warming up (90 sec.)
	Constant bulb with no symbol and "8888" is displayed	No lamp detected or lamp is 4000+ hrs old.
	Constant bulb with flashing no symbol	The lamp is 2000 - 4000 hours old. Replace lamp.
	Flashing bulb with constant no symbol	The lamp did not strike.
	Flashing bulb with constant no symbol, display shows the word "Cool"	The lamp is too hot to strike.

See [Section 11](#) for Troubleshooting.

2 Introduction

The X-Cite® 120Q represents a new standard in fluorescence illumination. It gives you the convenience and control never before available in a fluorescence illuminator and has been designed to let you focus your energy where it belongs, on obtaining the best possible results.

The heart of the X-Cite 120Q is a proprietary 120-watt short arc lamp with an improved 2000-hour typical lifetime. This extended lifetime is made possible by the proprietary thermal management system incorporated into the design. The lamp is mounted in an elliptical reflector with a proprietary coating to provide unequalled spectral and power output. The new X-Cite 120Q has also been improved for much quieter operation. Standard features incorporated in the X-Cite® 120Q include: the pre-aligned Intelli-Lamp® system, an accumulative lamp hour meter and a lamp status indicator.

The X-Cite 120Q joins the Excelitas Technologies family of light systems offering the same high level of innovation, quality and reliability that our commercial customers have come to expect.

Excelitas Technologies Corp. is a global technology leader focused on delivering innovative, customized solutions to meet the lighting, detection and other high-performance technology needs of customers. X-Cite®, formerly of Lumen Dynamics (which was acquired by Excelitas Technologies Corp. in November 2013) offers the Life Science and Analytical Instrumentation market a broad range of innovative lamp and LED fluorescence illumination and measurement solutions.

The X-Cite 120Q is a high quality product manufactured in accordance with ISO 9001, CE marked and certified to UL and CSA standards.

We suggest that you read this manual to discover all features, and how to use them.

Thank you for choosing X-Cite!

3 Getting Started

Carefully unpack the unit and accessories.

3.1 Box Contents:

1. X-Cite 120Q Illumination Unit.....
2. Lamp Module, X-Cite 120Q
3. Collimating Adapter (if ordered).....
4. Light Guide, X-Cite 120Q (3mm x 1.5m or 3mm x 3.0m).....
5. Power Cord, IEC (grounded).....
6. X-Cite® 120Q Quick Start Guide (User Guide download:
<http://www.excelitas.com/Pages/Product/X-Cite-120Q.aspx>).....
7. Hex Key, 3mm (lamp access cover).....
8. Safety Precautions Booklet.....

Store the packing material for future use.

If your packaged unit is missing any of the above components,
call Excelitas Canada Inc. at (905) 821-2600
or TOLL FREE 1-800-668-8752.

Any additional optional items purchased to customize the unit will also be present.

3.2 Front Panel

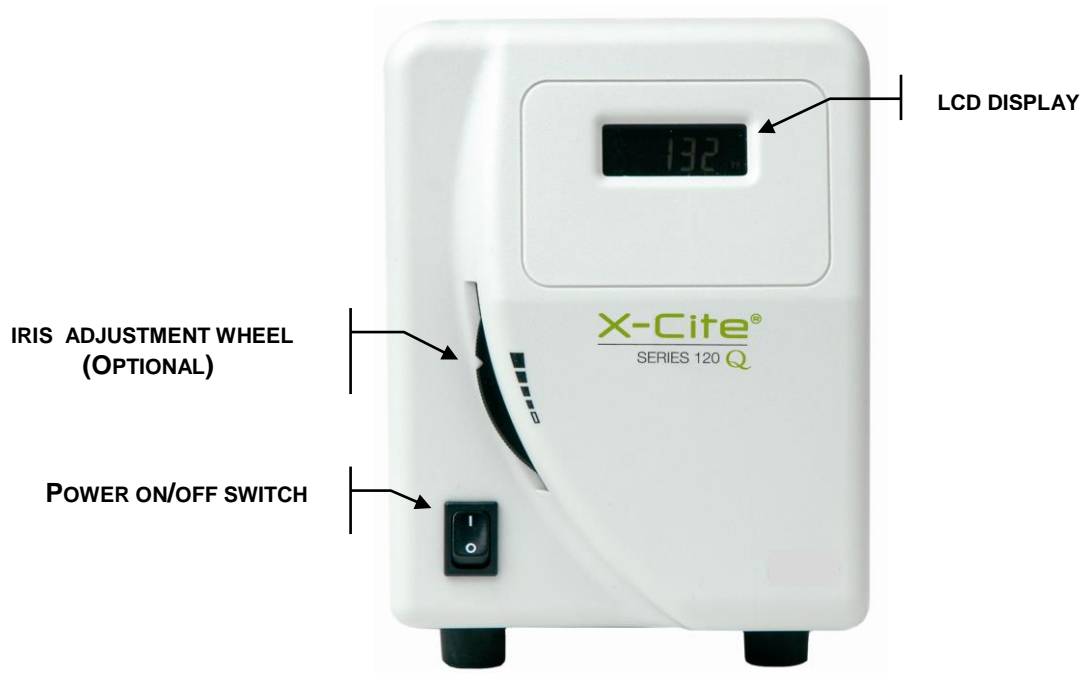

Figure 1 Front Panel View



3.3 Rear Panel



Figure 2 Rear Panel View

4 Safety Information

4.1 Glossary of Symbols

Symbol	Meaning
	CAUTION - Risk of danger: consult accompanying documents
	WARNING – Eye damage may result from directly viewing ultraviolet light. Protective eye shielding and clothing must be used at all times.
	CAUTION – Hot surface

4.2 Safety Precautions

The X-Cite® 120Q is equipped with two safety sensors to protect the user from accidental UV exposure. In addition, please observe the following precautions during use. This series of cautions, warnings and dangers relate to the operation and maintenance of the X-Cite® 120Q. They are also presented throughout this User's Guide where necessary.



Warning

Eye damage may result from directly viewing the light produced by the lamp used in this product. Always use protective eyewear and turn the lamp off before removing cover.



Caution

Never look into the light emitting end of the light guide. The light could severely damage the cornea and retina of the eye if the light is observed directly. Eye shielding must be used at all times as well as clothing to protect exposed skin.



Warning

Always make sure the light guide is properly inserted into the X-Cite® 120Q and the microscope prior to turning on power to the unit. This will minimize the risk of exposure to the UV light.



Caution!

To prevent damage/ degradation of the light guide, always allow adequate clearance at the rear of the X-Cite unit to prevent kinking or excessive bending.



Warning

To reduce the risk of fire or shock, always replace the fuses with the same type and rating.

**Warning**

Disconnecting of mains supply source is only possible by unplugging the attachment plug.

**Warning**

This unit is designed for bench top use only! Always ensure that the unit is operated on a hard, stable surface. This will prevent obstruction of the bottom chassis ventilation openings. Any obstruction of these openings could result in a possible over-heating condition. Do not attempt to remove or tamper with the rubber feet located on the bottom of the unit.

**Danger**

This unit contains HIGH VOLTAGE components. It is recommended that ONLY QUALIFIED TECHNICAL PERSONNEL perform any testing or repairs described in this manual. Disconnect the AC power cord from the unit before opening the cover of this unit. All cover screws must be replaced prior to applying power to the unit, or safety of the unit will be impaired.



Monitoring the unit during manual operation

The level of UV energy supplied by the X-Cite 120Q is sufficient to ignite flammable substances. During manual operation, the unit must be attended at all times by a qualified operator. The unit must not be left unattended while turned on. If an operator leaves the work area of the unit, the lamp power switch must be turned off.



Monitoring the unit during automated operation

The level of UV energy supplied by the X-Cite 120Q is sufficient to ignite flammable substances. Therefore, when the unit is operated unattended in an automated environment, an alarm function must be provided by the user to indicate a malfunction in the associated equipment used.



Warning

Hg – LAMP CONTAINS MERCURY, Manage in Accord with Disposal Laws, see: www.lamprecycle.org or 1-800-668-8752



Danger: Exposure to Mercury represents a health hazard to humans.

When unpacking or installing the lamp, always wear protective clothing and a face mask. Operate the lamp inside the X-Cite 120Q lamp housing only. This prevents direct viewing of the arc and in the case of lamp bursting, contains the lamp particles. In the rare instance in which a lamp bursting occurs, and the mercury content is released, the following safety precautions are recommended; all personnel should be immediately evacuated from the area to prevent inhalation of the mercury vapour. The area should be well ventilated for a minimum of 30 minutes. Prior to clean up ensure an 'approved-for-mercury' respirator mask and non-porous gloves such as latex or rubber are used. After the lamp housing elements have cooled, the mercury residue should be collected with the use of a special absorbing agent available from laboratory equipment suppliers.



Warning

Should this X-Cite 120Q unit be used in a manner not specified by Excelitas Technologies, the protection provided by the equipment may be impaired.

**Warning**

The method in which lamps are disposed of must comply with local rules & regulations for disposal of hazardous materials. Lamps may be returned to [Excelitas Technologies](#) providing they are returned in their original packaging. Excelitas Technologies will dispose of them in the appropriate manner.

Caution

The lamp module's operational life can be significantly shortened if it is handled incorrectly. Do not touch the bulb's glass envelope or the inside surface of the reflector. Skin oils can cause the lamp module to fail prematurely.

Caution

Prior to opening the unit and handling the lamp module, allow the lamp module to cool down completely.

**Caution**

Any electronic equipment connected to the X-Cite 120Q must be IEC950 certified.

**Cleaning:**

Clean exterior of the unit with a water dampened cloth and simple detergent only.

5 Installing the Lamp Module



Note: Refer to Section 4 – Safety Precautions, before proceeding

- 5.1.1 Be sure the AC power cord is disconnected from the unit.
- 5.1.2 *Remove the screw from the top of the lamp access panel using the 3mm hex key provided and remove the panel.*

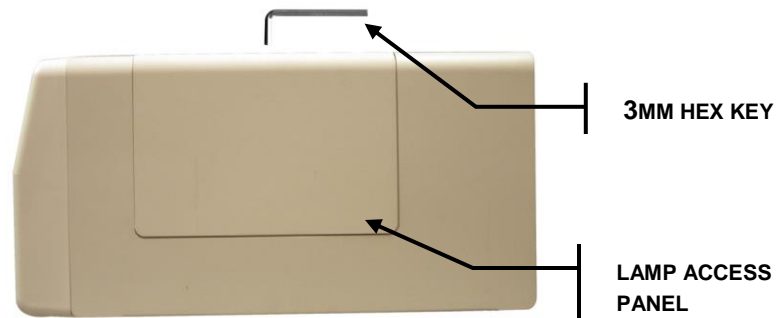

Figure 3 Side Panel-Lamp Access Panel

- 5.1.3 Carefully remove the lamp module from its container, holding only the ceramic components.



Caution!

The lamp module's operational life can be significantly shortened if handled incorrectly. Be sure only to handle the ceramic surfaces. Do not touch the bulb's glass envelope or the inside surface of the reflector. Skin oils can cause the lamp module to fail prematurely.

5.1.4 Open the lamp bracket arm by pulling towards you, refer to [Figure 4](#).

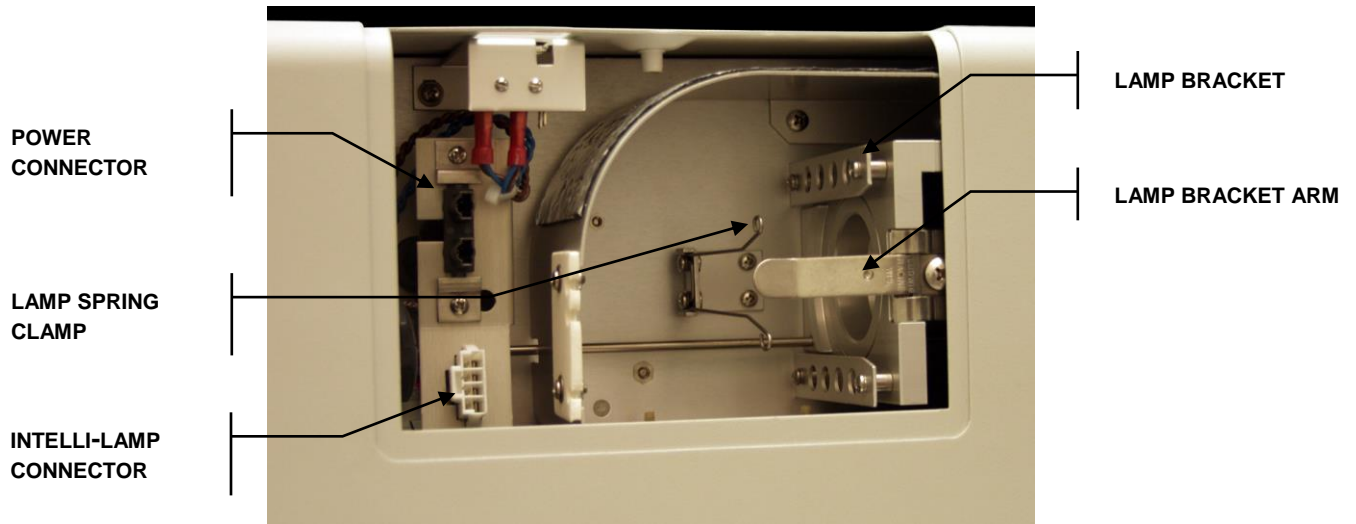

Figure 4 Lamp Housing

5.1.5 Position the lamp so that the two leading edges of the lamp ceramic mount slide into the groove of the lamp bracket. The middle of the lamp should be in position to fit into the spring clamp. Reference [Figure 5](#).

Tip: Make sure that the “This side out” label is facing outwards before trying to insert the lamp. Reference [Figure 5](#).

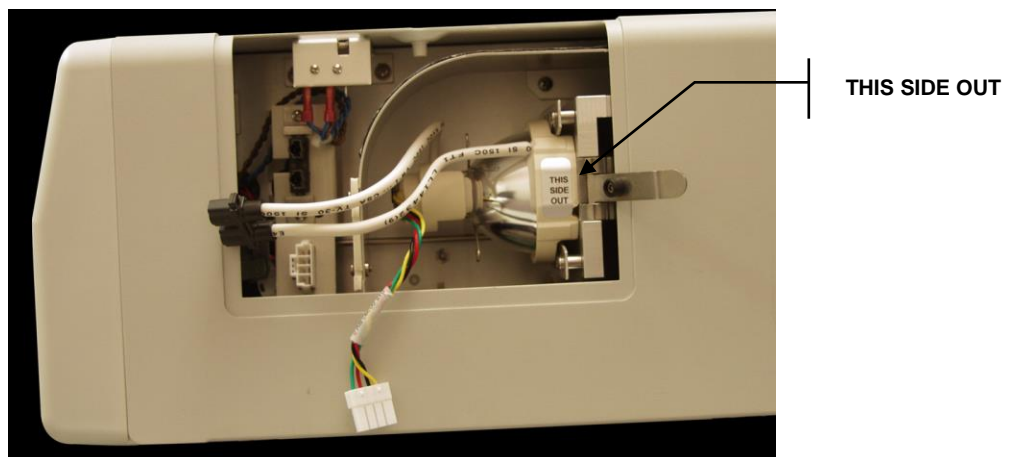

Figure 5 Lamp Orientation

- 5.1.6 Slide the lamp all the way in so that both leading edges of the lamp ceramic mount are in the groove of the lamp bracket. The middle of the lamp will snap into the spring clamp. Close the lamp bracket arm. Reference [Figure 5](#).
- 5.1.7 Locate the 4-pin Intelli-Lamp sensor connector (Multi-coloured wiring harness) at the rear of the lamp module and connect it to its mate located on the lamp-housing wall. Reference [Figure 6](#).

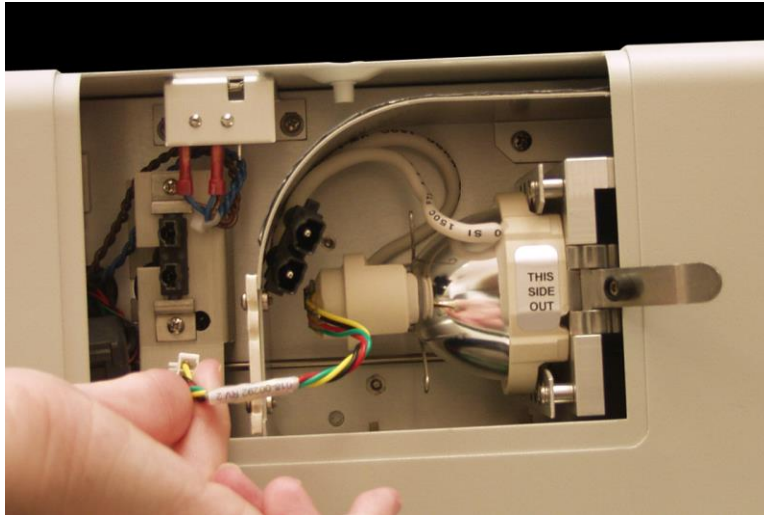

Figure 6 Intelli-Lamp Connection

Tip: *The Intelli-lamp connector will only attach in the correct orientation. If you are having difficulty attaching the connector, try rotating it by 180°*

5.1.8 Attach the 2-pin lamp power connector to its mate on the lamp-housing wall.



Figure 7 Lamp Power Connection

Tip: *The 2-pin lamp power connector will only attach in the correct orientation. If you are having difficulty attaching the connector, try rotating it by 180°*

5.1.9 Secure the Intelli-Lamp and power wires into the grooves of the lamp housing. Reference [Figure 8](#).

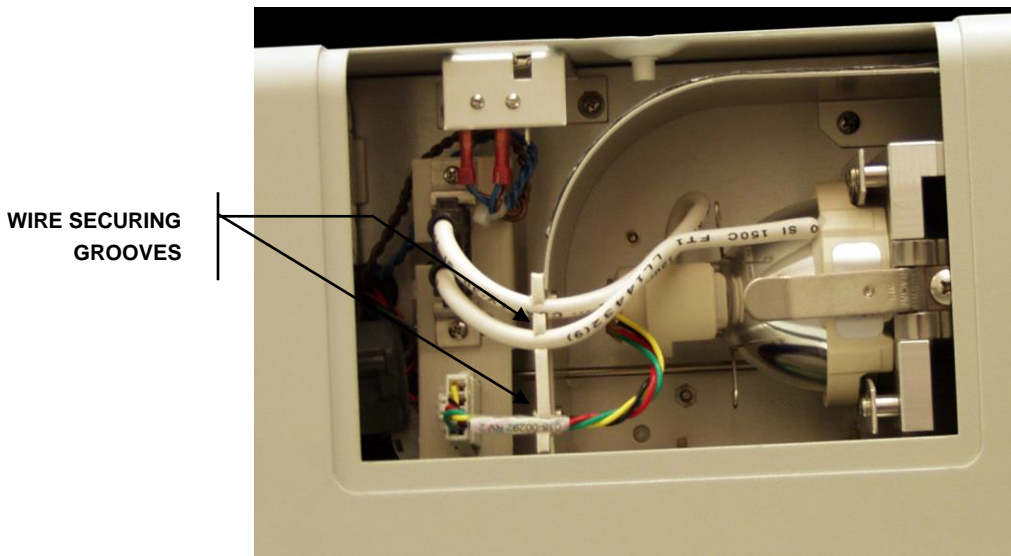

Figure 8 Lamp Wire Orientation

5.1.10 Replace the lamp access panel and tighten the fastening screw. Reference [Figure 3](#).



Note: *If the lamp is not installed correctly, the constant lamp with a “no” symbol will display when power is turned on to the unit.*



Warning

This unit is designed for bench top use only! Always ensure that the unit is operated on a hard, stable surface. This will prevent obstruction of the bottom chassis ventilation openings. Any obstruction of these openings could result in a possible over-heating condition. Do not attempt to remove or tamper with the rubber feet located on the bottom of the unit.



6 Inserting and Removing the Light Guide

- 6.1.1 Make sure that power is off to the X-Cite 120Q unit.
- 6.1.2 Ensure that the protective end caps are removed from both the input and output ends of the light guide prior to installation.
- 6.1.3 Insert the light guide into the light guide retainer located on the back panel of the unit. Push the light guide in until it seats with a second positive "click" (up to the "A" line printed on the grey ferrule). Reference [Figure 9](#).



Figure 9 Light Guide Insertion

Tip: When the light guide is fully inserted, the line on the light guide insertion label will be right up against the light guide port.

Note: If the light guide is not inserted properly, it may result in reduced light output and overheating which can cause premature degradation of the light guide.

- 6.1.4 During installation or removal, grasp the light guide on the strain-relief nearest the input end of the light guide. Reference [Figure 9](#).

Note: Never grip the light guide during installation or removal in a place other than the strain relief portion of the light guide.

- 6.1.5 To remove the light guide, firmly grip the strain relief near the light guide retainer and pull out firmly.

Note: The X-Cite 120 is designed for use with a 3mm liquid light guide. Excelitas Technologies cannot guarantee the performance of the X-Cite if using light guides other than those supplied by Excelitas

Tips to Prevent Premature Degradation of Light Guides

Refer to [section 11](#) for detailed set-up and maintenance tips.

- 6.1.6 Liquid light guides have a typical useful life of 2-3 years in the X-Cite 120Q when installed and handled properly. The formation of bubbles is one of the most common reasons for a light guide to degrade prematurely and result in a sudden reduction in illumination intensity. Bubbles form without warning, usually due to overheating and/or mechanical stress to the light guide. Below are some simple tips to avoid overheating and stressing the light guide.
- 6.1.7 The light guide has a minimum bend radius of 1.6 inches (40.0mm). Bending or coiling the light guide tighter than this radius will result in permanent damage to the light guide.
- 6.1.8 Make sure the light guide is cooled properly during use, and prevent overheating:
 - a. Always fully insert the light guide in to the X-Cite unit; this ensures contact with a heat sink to conduct heat away from the light guide.
 - b. Never obstruct the air vents on the X-Cite unit. Vents are located at the rear and underside of the unit. (Note: In earlier X-Cite models, vents were located on the side, underneath the lamp access panel.)
 - c. Do not remove the rubber feet on the X-Cite unit or otherwise reduce/block the space between the bottom of the unit and bench top. This may compromise airflow through the unit.
 - d. Ensure that the air being used to ventilate the X-Cite unit is approximately “room temperature” (e.g. do not place the X-Cite unit on top of another heat-producing instrument).
 - e. If a heated environmental chamber is being used for live cell imaging, make sure that the X-Cite unit and the light guide are located outside of the chamber.
- 6.1.9 Do not expose the light guide to extreme temperatures (above 35°C, below -5°C) for extended periods of time during use, transport or storage; this may cause degradation of the seals and allow air bubbles to form in the liquid.

- 6.1.10 Never kink, bend, crush, or stretch the light guide; this type of mechanical stress may cause bubbles to form in the liquid and/or damage to the outer sheath;
- a. Always allow adequate clearance at the rear of the X-Cite unit to prevent excessive bending.
 - b. Place the X-Cite unit close enough to the microscope so that there is some slack in the light guide and no sharp bends.
- 6.1.11 Never leave an endcap on the output end of the light guide when the other end is connected to the X-Cite unit; if the unit is turned on in this condition, the cap will overheat, melt and/or permanently discolour the quartz end of the light guide.
- 6.1.12 While the X-Cite unit is on but not in actual use (i.e. during sample preparation, or between time-lapse time points) close the iris/shutter on the X-Cite; this reduces unnecessary UV photon load on the liquid light guide. (Using only the shutter/stop in the microscope itself protects the specimen, but energy is still passing through the light guide.)

7 Installing the Collimating Adapter

- 7.1.1 Make sure power is off to the X-Cite 120Q unit.
- 7.1.2 The existing lamp housing must be removed from the microscope before the collimating adapter can be mounted. Do not discard the existing mounting hardware, since it will be used to secure the collimating adapter to the microscope.
- 7.1.3 Remove the collimating adapter from its packaging.

Note: *The collimating adapter has been set at the factory. No adjustments by the customer are required.*

- 7.1.4 Insert the flange portion of the collimating adapter into the lamp port of the microscope. Using the existing hardware, tighten the screw(s) until the flange is fully secured.

Note: *The installation of the collimating adapter will vary with microscope models.*

- 7.1.5 Remove the protective cap from the output end of the light guide. Insert the light guide into the input portion of the collimating adaptor until it is flush with the adjustable insert. Secure the light guide to the collimating adaptor by tightening the thumbscrew. Do not over tighten.

Note: *The light guide has a minimum bend radius of 1.6 inches (40.0mm). Bending or coiling the light guide tighter than this radius will result in permanent damage to the light guide.*

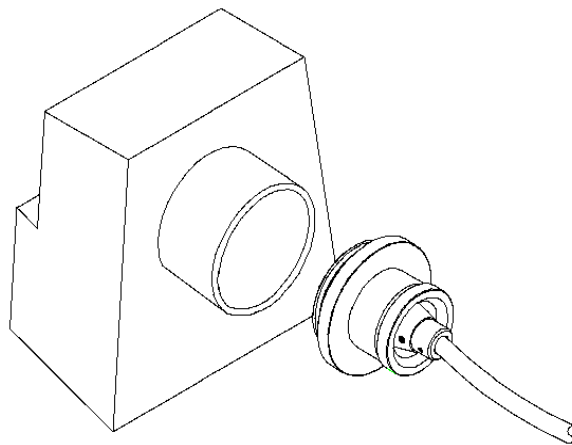

Figure 10 Collimating Adaptor



Warning!

Turning power on to the X-Cite 120 unit without the light guide properly installed in the unit and in the microscope can increase your risk of exposure to UV light.

8 Powering Up and Powering Down



Lamp Warm-Up:

The ARC lamp has 3 distinct phases of operation;

1. Ignition.
2. Warm-up. *Excelitas Technologies recommends 20 minutes of proper warm-up to ensure a stable optical output.*
3. Stable Operation.

It is recommended that phase 1 and 2 are not interrupted. This can result in shortened lamp life. **The lamp must be allowed to warm-up uninterrupted.**

- 8.1.1 Ensure that the lamp and light guide have been properly installed and that the cover is securely fastened.
- 8.1.2 Plug the X-Cite 120Q unit into a properly grounded AC outlet.



Warning!

Turning power on to the X-Cite 120 unit without the light guide properly installed in the unit and in the microscope can increase your risk of exposure to UV light.



Warning!

To avoid exposure to UV light or burning the light guide protective cap, ensure the Iris Adjustment Wheel is set to 0% before turning on the main power switch. Refer to [paragraph 10.1.2](#)

- 8.1.3 Ensure the Iris Adjustment Wheel is set to 0% before tuning on main power switch. Refer to [paragraph 10.1.2](#).
- 8.1.4 Turn on the mains power switch, located on the front panel and check the fan for airflow.
- 8.1.5 The lamp indicator symbol in the display window will illuminate, and the display will flash for the warm up period of 90 seconds. For the first 15 seconds, the display will show “8888” while the unit performs internal checks. When this process is complete, the accumulated lamp hours will appear on the display as ‘XXXX H’. Wait for the warm up period to finish before using the X-Cite 120Q on an application. **Excelitas Technologies recommends 20 minutes to ensure a stable output.**

Note: Unit should not be turned off unless the lamp has been on for a minimum of 20 minutes.



Note: *If the lamp is turned off, and an attempt is made to turn it back on before it has fully cooled, the flashing bulb and “no” symbol may appear on the display with the message “Cool”. When the lamp has cooled, the unit will automatically reinitialize and strike the lamp.*

- 8.1.6 To power down the unit, turn off the mains power switch, located on the front panel.

9 Viewing the Accumulated Lamp Hours

- 9.1.1 The accumulated lamp hours are continuously shown on the LCD display on the front panel of the unit. The lamp hours are automatically updated.

10 Adjusting the Illumination (Optional)

10.1.1 If your X-Cite 120Q system includes the optional iris adjustment, then it is possible to manually change the amount of illumination out of the unit.

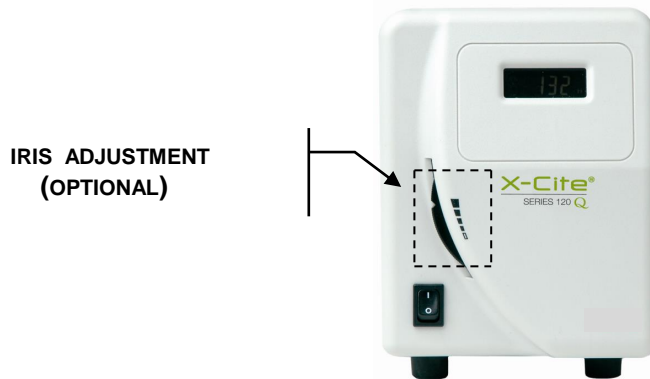
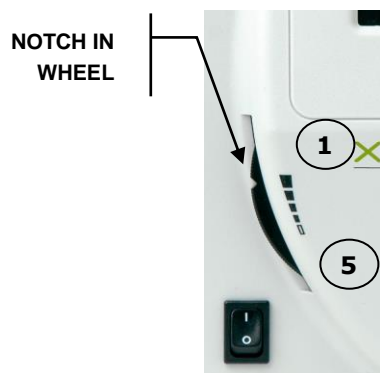

Figure 11 Iris Adjustment Wheel

10.1.2 The iris adjustment includes 5 different illumination settings.



1. 100% of the total illumination
2. 50% of the total illumination
3. 25% of the total illumination
4. 12% of the total illumination
5. 0% of the total illumination

Note: Settings levels are approximate values

Figure 12 Iris Adjustment Settings

10.1.3 To increase the amount of illumination from the unit;

1. Turn the iris adjustment wheel upward to increase the illumination to the next setting.
2. The notch in the iris adjustment wheel shows the current setting of the iris.

10.1.4 To decrease the amount of illumination from the unit;

1. Turn the iris adjustment wheel downward to decrease the illumination to the next setting.
2. The notch in the iris adjustment wheel shows the current setting of the iris.

11 Troubleshooting

11.1 General

Service to be completed by qualified repair personnel only!



If the unit fails to power up or function properly, use the following checklist to eliminate the most common causes of problems. Check that:

1. The AC power cord is securely plugged into a functional AC wall plug.
2. The AC power cord is securely plugged into the AC inlet on the rear of the unit.
3. The mains AC power switch is in the ON position.
4. Check that the ventilation openings both on the bottom and rear of the unit are not blocked.

If the LED display lights and the fan starts, but the lamp won't turn on, check that:

1. The LED display indicates the constant bulb with the “no” symbol. This indicates that no lamp is detected. Check if the lamp has been installed correctly. Refer to [section 5](#) – Installing the Lamp Module. 
2. The lamp may have reached the end of life. Power down the unit, wait a few minutes and turn power on to the unit. If it still does not strike, replace the lamp.

Note: *If lamp life has reached 4,000 hours, it is necessary to replace the lamp module.*

3. The LED display indicates the flashing bulb with the constant “no” symbol. This indicates the lamp did not strike. If the lamp was just recently turned off, it may be too hot to strike. The lamp will automatically strike when it has cooled. 
4. The LED display indicates the flashing bulb for 90 sec. to show lamp warming, then indicates the flashing bulb with the “no” symbol. This indicates that the lamp housing panel is not secured properly in place. Remove the lamp housing panel and replace securely, tightening the fastening screw in place. 

If the light intensity is too low, check that:

1. The light guide has been fully inserted into the light guide retainer.
2. If the X-Cite 120Q unit includes the optional iris adjustment, turn the adjustment wheel upward to increase the illumination. See [section 10](#) – Adjusting the Illumination.
3. There are no foreign substances on the emitting end of the light guide.
4. There are no bends, kinks, or other physical damage to the guide. Replace the guide if there is any physical damage.
5. The lamp has been installed correctly. See [section 5](#) – Installing the Lamp Module.

It may be necessary to replace the lamp or to replace the light guide. Contact your [service representative](#) for information on purchasing a new lamp or light guide.

If the LED display does not light:

1. If the fan is functional, power down the unit, wait approximately 20 seconds then power it up again.
2. If the problem persists, contact your local [service representative](#).

If the Fan does not work properly

1. If the LED display is functional, power down the unit, wait approximately 20 seconds then power it up again.
2. If the problem persists, contact your local [sales representative](#).

11.2 Liquid Light Guides

Proper handling and installation of liquid light guides

1. Liquid light guides have a typical life of 4000 hours of operation when handled properly and installed in a well maintained X-Cite 120Q. The formation of bubbles is one of the most common reasons for a light guide to degrade prematurely and result in a sudden reduction in illumination intensity. Bubbles can form without warning, and if they occur within the first 1500 to 2000 hours of use, is it typically due to overheating and/or mechanical stress to the light guide. Below are some simple tips to avoid overheating and stressing the light guide.
2. Always fully insert the light guide in to the X-Cite unit (i.e. up to the “A” line printed on the grey ferrule); this ensures contact with a heat sink to conduct heat away from the light guide.

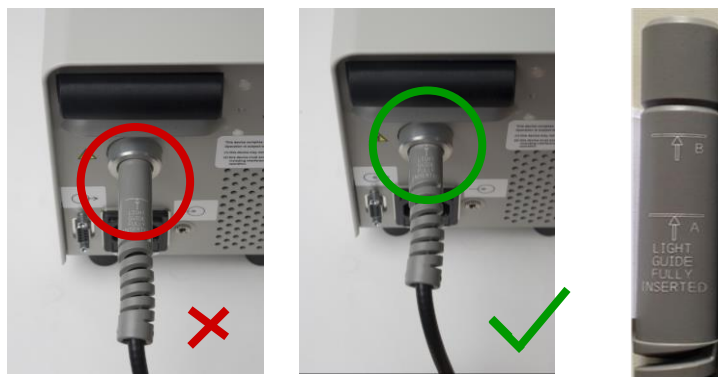

3. Always allow adequate clearance at the rear of the X-Cite unit and microscope to prevent excessive bending and/or crushing of the light guide against walls. Minimum bend radius to prevent immediate damage to the LLG is 40mm, however, a bend radius of at least 75mm is recommended for a light guide while “in use”. Sharper bends can cause heat to build up and cause problems longer term.

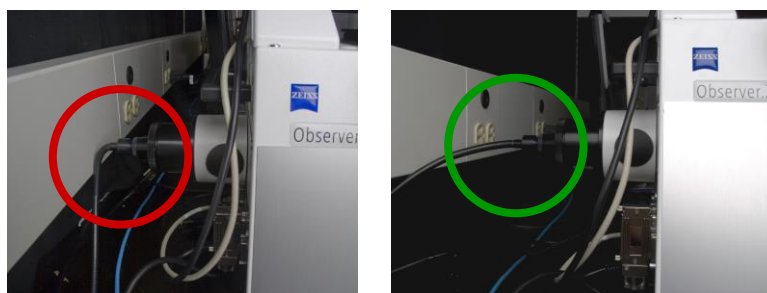

4. Always place the X-Cite unit close enough to the microscope so that there is some slack in the light guide and no sharp bends.

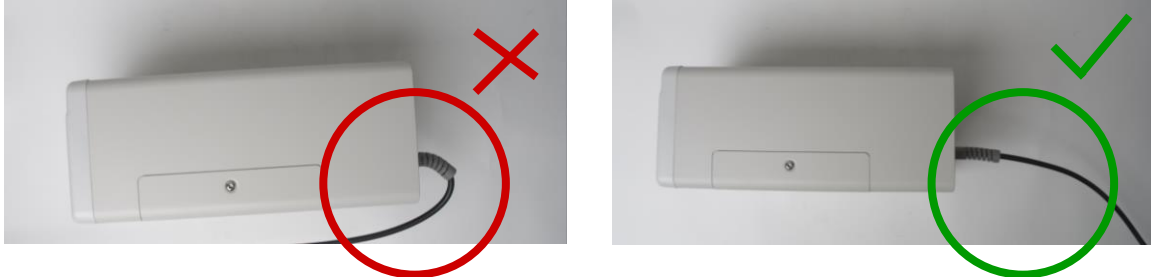

5. Never leave an endcap on the output end of the light guide when the other end is connected to the X-Cite unit; if the unit is turned on in this condition, the cap will overheat, melt and/or permanently discolor the quartz end of the light guide.
6. Do not expose the light guide to extreme temperatures (above 35°C, below -5°C) for extended periods of time during use, transport or storage; this may cause degradation of the seals and allow air bubbles to form in the liquid.

What does a bubble look like?

Depending on the size and location in the light guide, a bubble may or may not be obvious. To check for bubbles:

1. Disconnect the LLG from the X-Cite and microscope adapter.
2. Hold one end towards a bright window or overhead room light - DO NOT use an X-Cite or any other focused light source for this test!
3. Look at the quartz at the other end of the LLG;
 - a. Bubble-free: quartz end will appear as a bright, solid circle; you may also be able to see a thin circular outline at the quartz/liquid interface.
 - b. Bubbles at/near the quartz end: appear as dark spots, as small as 0.5mm in diameter or even as larger more defined spheres.
 - c. Bubbles in the middle of the light guide: may not be well-defined spots, but will appear as dark shadows.

- d. In extreme cases, where the bubble is blocking the entire diameter of the light guide, no light will come through, even when pointing the distal end at a light source.

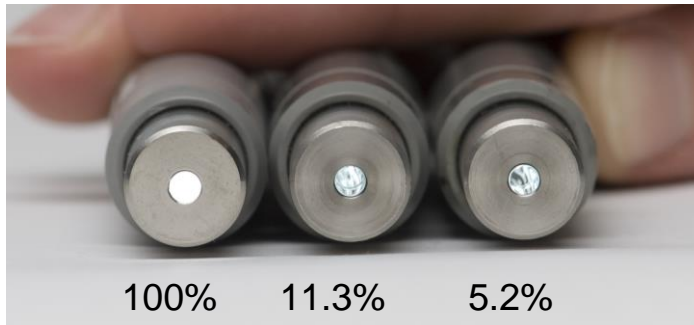

Appearance and % output of light guides with bubbles relative to an LLG without bubbles (100%).

Can a bubbled light guide recover?

Yes, light guides with small bubbles can sometimes recover. Disconnect the light guide from the X-Cite unit, and leave the light guide undisturbed on a shelf for 1-2 weeks. For this to be effective, it is important to catch the bubble when it is small.

When should light guides be replaced?

It is usually time to replace a light guide when:

- Illumination is low and replacing the lamp does not improve brightness.
- Dark or uneven areas become visible in the field of view (a bubble is blocking part of the light).
- A section of the light guide becomes noticeably warmer than the rest of the guide (a bubble is blocking transmission of light, forcing the light guide to absorb the energy).
- It is 2-3 years old, OR has been in use for 4000-6000 hours (2-3 lamp changes).

11.3 Lamps

Performance and lifetime

The lamp output spectra and typical output levels over lifetime are shown below.

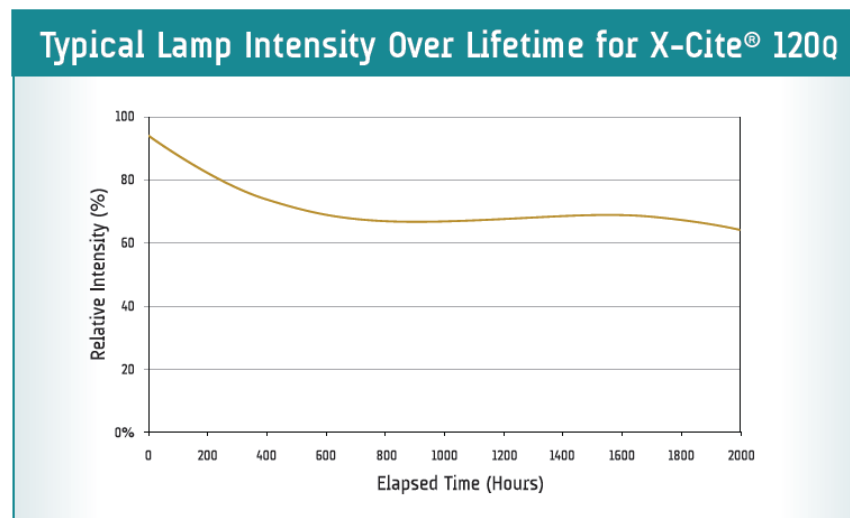
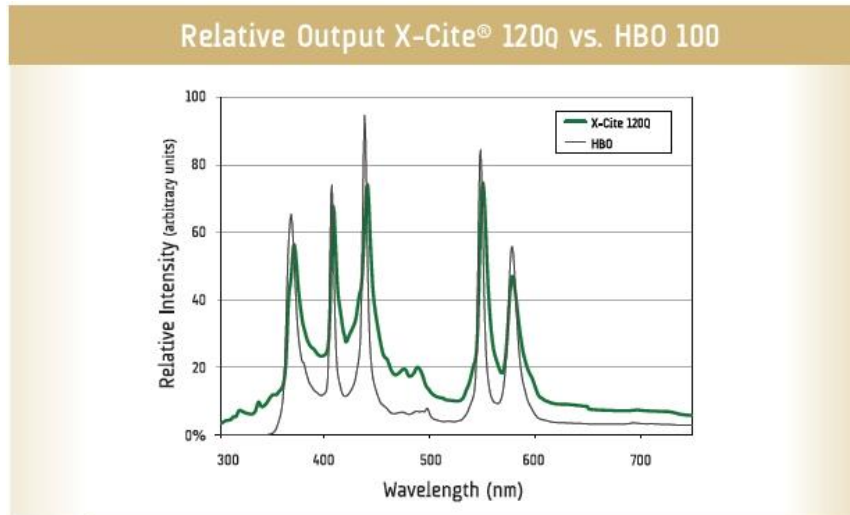

It is normal for the output to decline over the first several hundred hours of use and then stabilize at a level ~70% of the initial output for the remainder of the lamp life. If the lower power regions of the output spectra are being used, it may be desirable to replace lamps more frequently to maximize signal levels.

11.4 Air Vents & Filters

X-Cite units have several air vents that are an integral part of the cooling system and overall lamp performance. Proper cooling ensures that lamps operate at optimal temperature and pressure for output power, spectrum, lamp life, light guide life and safety.

Ensuring adequate cooling

1. Never obstruct the air vents on the X-Cite unit. Vents are located at the rear and underside of the unit. (Note: Arrows indicate direction/location of air flow. In earlier X-Cite models vents were located on the side, underneath the lamp access panel.)



2. Always leave clearance for air flow between the X-Cite and walls or other equipment. Do not remove the rubber feet on the X-Cite unit or otherwise reduce/block the space between the bottom of the unit and bench top. This may compromise airflow through the unit.

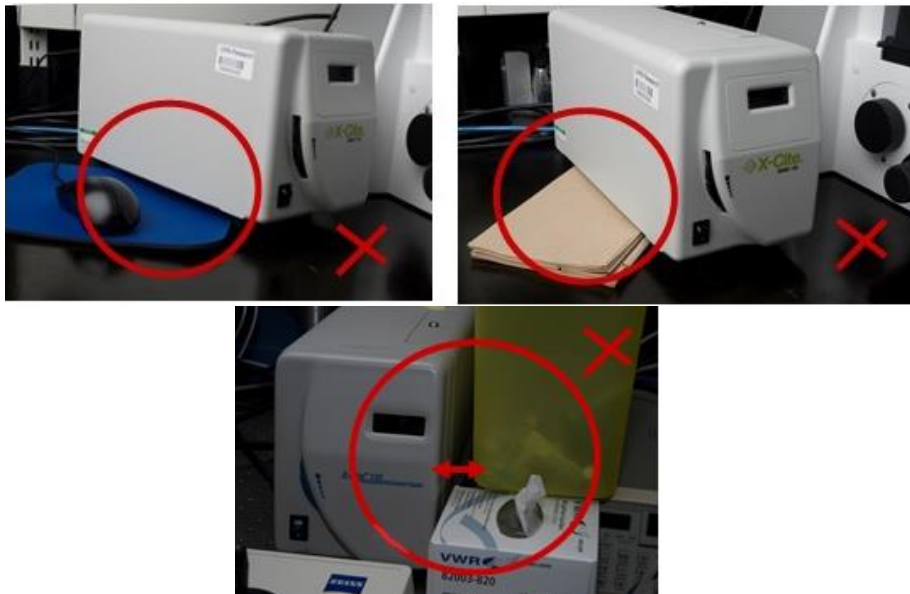

3. Ensure that the air being used to ventilate the X-Cite unit is approximately “room temperature” (e.g. do not place the X-Cite unit on top of another heat-producing instrument).
4. If a heated environmental chamber is being used for live cell imaging, make sure that the X-Cite unit and the light guide are located outside of the chamber.
5. Periodically check the air filter at the air intake vent for debris. Replace or clean as necessary.

How to check/clean X-Cite 120Q metal vents

1. When unit is OFF and lamp is COOL, unplug power from X-Cite unit and turn unit upside down. Visually inspect the metal gratings for lint, dust and other debris.
2. Debris can be removed from the gratings using a small vacuum cleaner with a crevice tool, or blown out with a can of compressed air. If using compressed air, direct the air flow ACROSS the vents, not perpendicularly (i.e. into the X-Cite unit).

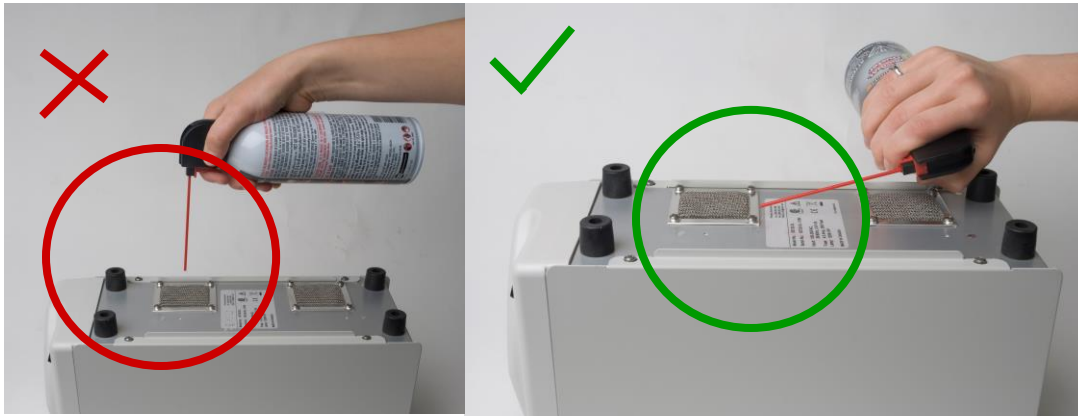

How to check/clean X-Cite 120Q (original design) nylon filters

1. Visually inspect the perforations on the side of the unit, under the lamp access door. You should be able to see a grey mesh filter on the inside of the unit. This filter requires cleaning or replacing if:
 - Dust/lint/debris has accumulated.
 - Dust/lint/debris is blocking the view of the grey mesh filter.
 - The filter looks as though it is crumbling.
2. It is possible to clean newer filters, but it is generally better to replace them, as they tend to deteriorate over time (one reason they stopped being used in X-Cite units in 2006). Contact [Excelitas Technologies Tech Support](#) for additional information on cleaning/replacing filters.

What happens if filters are not clean?

A complete filter blockage or airflow obstruction generally results in an automatic lamp shutoff within 10-15 minutes of the unit being powered on due to lack of adequate cooling.

A partially clogged filter may allow enough airflow for continued operation, but not for optimal cooling. In this case, the result is usually dramatically reduced lamp life, e.g. 400 hours instead of 2500+ hours.

12 Routine Care and Maintenance

1. Operate the unit in a well ventilated area with at least six inches clearance at the rear of the unit for proper air flow. Do not place any objects below the unit or between the feet as this will restrict airflow through the bottom of the front face plate.
2. For safe operation, use only a grounded outlet.
3. Avoid physical shocks or jarring to the unit especially while the unit is operating. Such sudden movements reduce the lamp module life.
4. The lamp module must be operated for a minimum of 20 minutes each time it is turned on to prevent damaging the lamp. Increasing the time between turning the lamp module on and off will maximize lamp life.
5. When necessary, clean the light emitting end of the light guide using an optical cleaning solution.
6. Cleaning of unit is not required, however if cleaning is desired, disconnect the AC power cord from the unit and use only a water and simple detergent solution. Ensure that cleaning solution does not come in contact with any optical, moving mechanical or electrical parts.
7. Recommended operation of the X-Cite 120Q is in horizontal position using the X-Cite 120Q beyond 15% of tilt from a horizontal position will wear lamp life.

12.1 General tips to help maximize lamp lifetime:

1. Each time the lamp is ignited, the stress on the lamp effectively decreases lamp life by 5 hours, therefore it is recommended to avoid shutting down the unit during lunch or short breaks or between users, if being used in a multi-user lab.
2. After lamp ignition, avoid turning the lamp off until it has run for a minimum of 20 minutes.
3. Avoid attempting to strike a hot lamp (note: the X-Cite's Intelli-Lamp will prevent this).
4. Avoid unnecessary movement and jarring of the lamp, especially when it is in operation or hot.
5. When changing a lamp:
 - a. Handle the lamp only by the ceramic areas.
 - b. Never touch the glass envelope of the bulb (inner stem), the inner surface, or the outer surface of the reflector. If touched, carefully clean the envelope with alcohol. Skin oils can etch the glass and cause premature bulb failure.
 - c. Wear cotton gloves or powder free latex gloves when handling any lamp.
6. Ensure that air filters are kept clear of dust and debris – even a partially blocked filter can reduce lamp lifetime to approximately 25% of what is normally expected.

13 Technical Specifications

13.1 Lamp module

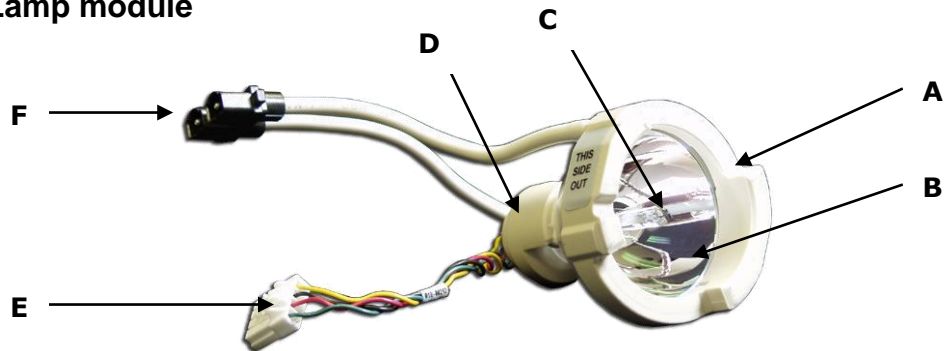

A, D: Ceramic Components. **B:** Reflector. **C:** Bulb.
E: Intelli-Lamp Connector. **F:** Lamp Power Connector

Lamp Module	High Pressure 120 watt mercury short arc
Lamp Module Life	2000 hours (typical)
Warm Up	90 seconds (typical)

13.2 Light guide

Light Delivery

Flexible liquid filled light guide 1.5m or 3m in length with a core diameter of 3mm. Custom light guides are also available.

Liquid Light Guide End Fitting

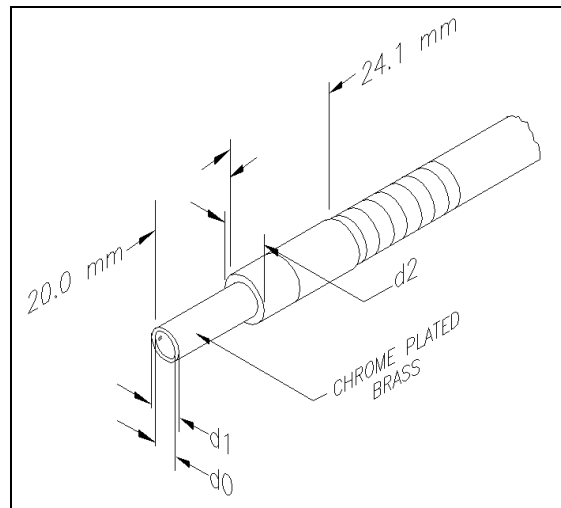

Liquid Light Guide Dimensions in mm

Core	End Fitting	End Fitting	Minimum Bend Radius (mm)
d0	d1	d2	
3	5	9	40

13.3 Power Input

Power Supply:	High efficiency, switch mode, constant power output
Input Voltage:	100-240V, 50/60Hz
Current:	2.4 – 1.0A (100/ 240V)
Input Surge:	50A max. (cold start)
Protection:	Short circuit protection Overvoltage (up to 135%, +/- 5% of nominal) EMI filtering integrated into the PFC module Lamp driver circuit has integrated thermal cut-off
Fuse Rating:	Dual fuse system: each fuse rated at F4A 250V (Fast acting type)

13.4 Lamp power (electrical)

Lamp Voltage:	85V RMS, square wave, 50% duty cycle, 1.4A typical
Output Power:	Lamp: nominal 120W
Max. Lamp Voltage:	115V RMS
Lamp Drive Frequency:	150Hz
Line Regulation:	From min Vin to max Vin lamp: +/-2%

13.5 Environmental Specifications:

Operating Conditions

Operating Temperature:	5 to 40°C
Altitude:	2000m max.
Humidity:	15 to 90% RH (non-condensing)
Atmospheric Pressure:	70 to 106 kPa
Overvoltage Category:	II
Pollution Degree:	2

Transport and Storage Conditions

Temperature:	-10 to +70°C
Relative Humidity:	10 to 95% RH (non-condensing)
Atmospheric Pressure:	50 to 106 kPa

13.6 Regulatory Compliance

Product Safety and Electromagnetic Compatibility

The X-Cite 120Q has been tested and found to comply with product safety and electromagnetic compatibility requirements. For a complete list of tests and for certification details, please contact your X-Cite representative or visit <http://www.excelitas.com/Pages/Product/X-Cite-120Q.aspx>.

CE Marking

Council Directive 2014/35/EU

Council Directive 2014/30/EU

Council Directive 2012/19/EU

Council Directive 2011/65/EU

Low Voltage Directive

EMC Directive

WEEE Directive

RoHS



FCC Part 15, Subpart B, Class A Digital Device or Peripheral – Information to User

NOTE:

This equipment has been tested and found to comply with the limits for a Class A digital device, pursuant to Part 15 of the FCC Rules. These limits are designed to provide reasonable protection against harmful interference when the equipment is operated in a commercial environment. This equipment generates, uses, and can radiate radio frequency energy and, if not installed and used in accordance with the instruction manual, may cause harmful interference to radio communications. Operation of this equipment in a residential area is likely to cause harmful interference in which case the user will be required to correct the interference at their own expense.

Warning:

Changes or modifications not expressly approved by Excelitas Technologies could void the user's authority to operate the equipment.

WEEE Directive (2012/19/EU)



The symbol above indicates that this product should not be disposed of along with municipal waste, that the product should be collected separately, and that a separate collection system exists for all products that contain this symbol within member states of the European Union.

- The equipment that you bought has required the extraction and use of natural resources for its production. It may contain hazardous substances that could impact health and the environment.
- In order to avoid the dissemination of those substances in our environment and to diminish the pressure on the natural resources, we encourage you to use the appropriate take-back systems. Those systems will reuse or recycle most of the materials of your end life equipment in a sound way.
- The crossed-out wheeled bin symbol indicated above invites you to use those systems.
- If you need more information on the collection, reuse and recycling systems, please contact your local or regional waste administration.

13.7 China RoHS



The symbol above indicates that this product is in compliance with China RoHS requirements.

14 Warranty

Excelitas Technologies warrants the original purchaser for a period of one (1) full year, calculated from the date of purchase, that the equipment sold is free from defects in material and workmanship.

In the event of a claim under this guarantee, the equipment is to be sent postage and carriage paid, including a description of the fault, to the Excelitas Technologies Service Center. Returned equipment will not be received without a Return Authorization (RA) Number, issued by the appropriate Service Center.

In the case of damage caused by wear and tear, careless handling, neglect, by the use of force or in the case of interventions and repairs not carried out by an Excelitas Technologies Service Center, the guarantee ceases to be valid. This guarantee may not form the basis for any claims for damages, in particular not for compensation of consequential damages.

The warranty is not transferable. No warranty is extended to perishable items, such as fuses, air filters and light guides.

Any claims for units received with defects in material or workmanship must be reported to an [authorized Excelitas Technologies Service Center](#) within 30 days from the original date of receipt.

Replacement Bulb Warranty

If the X-Cite 120Q bulb fails to strike during the warranty period of 2000 hours, the bulb will be replaced under warranty, or a credit will be applied to the purchaser's account. In the event of a claim under this guarantee, the lamp is to be sent postage and carriage paid, including a description of the fault, to the Excelitas Technologies Service Center. Returned equipment will not be received without a Return Authorization (RA) Number, issued by the appropriate Service Center. Lamps must be purchased from an authorized Excelitas Technologies Representative or Distributor to be eligible for the warranty replacement. This warranty is non-transferable.

In the case of damage caused by careless handling, neglect, by the use of force or in the case of interventions and repairs not carried out by an Excelitas Technologies Service Center to the X-Cite® 120Q system, the guarantee ceases to be valid.

Returning equipment to Excelitas Technologies

1. Please make a note of the problem encountered, the steps followed to isolate the problem and the result of any trouble shooting steps taken.
2. Contact the nearest Excelitas Technologies Service Center to obtain a Return Authorization Number. For your convenience, RA numbers can also be requested on-line at: <http://www.excelitas.com/Pages/Support/Service-Request-Form.aspx>

- Follow shipping instructions provided by the service technician. The unit should be returned in its original packaging if possible. Please do not ship the unit with the lamp installed.

15 Contact Information

15.1 Web Page

Excelitas Canada Inc.
 Tel: (905) 821-2600
 Fax: (905) 821-2055
 1-800-668-8752 (USA and Canada)
x-cite@excelitas.com
<http://www.excelitas.com/Pages/Product/X-Cite.aspx/asc.php>

15.2 Service Centers

For a complete list of authorized service centers please visit:
<http://www.excelitas.com/Pages/Support/Service-Centers.aspx>

15.3 Replacement Parts

Replacement lamps and light guides can be purchased directly from Excelitas Technologies. For ordering and pricing information contact the inside sales department at:

x-cite@excelitas.com
<http://www.excelitas.com/Pages/Contact/Contact-Us.aspx>
 1-800-668-8752

Part Number	Description
012-63000	X-Cite® 120Q lamp module
Collimating Adapter – call to match microscope	
805-00038	X-Cite® 120Q Light guide (3mm x 1.5m)
805-00040	X-Cite® 120Q Light guide (3mm x 3.0m)
Grounded power cord (IEC) – call to match AC voltage	
850-00023R	Hex Key, 3mm (Lamp access cover)